

This article was downloaded by:

On: 25 January 2011

Access details: *Access Details: Free Access*

Publisher *Taylor & Francis*

Informa Ltd Registered in England and Wales Registered Number: 1072954 Registered office: Mortimer House, 37-41 Mortimer Street, London W1T 3JH, UK



Journal of Macromolecular Science, Part A

Publication details, including instructions for authors and subscription information:

<http://www.informaworld.com/smpp/title~content=t713597274>

Solid-State Polymerization of Acrylonitrile Induced by Reactor Radiation

Yoneho Tabata^{ab}

^a Department de Physico-Chimie, Service de Physico-Chimie Appliquée Centre d'Etudes Nucléires de Saclay, Saclay, France ^b Department of Nuclear Engineering, University of Tokyo, Tokyo, Japan

To cite this Article Tabata, Yoneho(1968) 'Solid-State Polymerization of Acrylonitrile Induced by Reactor Radiation', Journal of Macromolecular Science, Part A, 2: 5, 919 – 930

To link to this Article: DOI: 10.1080/10601326808051450

URL: <http://dx.doi.org/10.1080/10601326808051450>

PLEASE SCROLL DOWN FOR ARTICLE

Full terms and conditions of use: <http://www.informaworld.com/terms-and-conditions-of-access.pdf>

This article may be used for research, teaching and private study purposes. Any substantial or systematic reproduction, re-distribution, re-selling, loan or sub-licensing, systematic supply or distribution in any form to anyone is expressly forbidden.

The publisher does not give any warranty express or implied or make any representation that the contents will be complete or accurate or up to date. The accuracy of any instructions, formulae and drug doses should be independently verified with primary sources. The publisher shall not be liable for any loss, actions, claims, proceedings, demand or costs or damages whatsoever or howsoever caused arising directly or indirectly in connection with or arising out of the use of this material.

Solid-State Polymerization of Acrylonitrile Induced by Reactor Radiation

YONEHO TABATA*

*Département de Physico-Chimie
Service de Physico-Chimie Appliquée
Centre d'Études Nucléaires de Saclay
Saclay, France*

SUMMARY

Radiation-induced solid-state polymerization of acrylonitrile at low temperature is reported. It is pointed out that the rate of polymerization may be extremely rapid in the initial stage of polymerization in comparison with those induced with other radiation sources, that the effect of fast neutrons is significant in the polymerization, and that formation of both trans-vinylene and C=C bonds conjugated with C≡N groups can be observed only in polymerization initiated with reactor radiation.

INTRODUCTION

Investigations on radiation-induced solid state polymerization of acrylonitrile have been reported by several workers [1]. But studies on the effects of linear energy transfer (LET) and the energy of radiations for the polymerization have not yet been reported except for a few experiments [2]. Mixed strong radiations, composed of fast neutrons, thermal neutrons, and γ rays, can be obtained using a nuclear reactor as a radiation source. The effects of the fast neutrons, thermal neutrons, and γ rays, which have a broad energy spectrum on the polymerization, are very interesting from the viewpoint of LET studies. In this paper, the polymerization of acrylonitrile at a low temperature induced by the reactor radiation is reported.

*Present address: Department of Nuclear Engineering, University of Tokyo, Tokyo, Japan.

EXPERIMENTAL

Acrylonitrile monomers were dried by NaHSO_4 and distilled two times under ordinary pressure. The distilled monomers were introduced into an aluminum ampoule (Fig. 1). The ampoule was shielded mechanically under vacuum. The monomer ampoules were irradiated in a reactor (Mélusine CEA-G, 2 MW). The irradiation was carried out using a cryogenic rig (irradiation facility) installed in the swimming-pool type of reactor. The flux of fast neu-

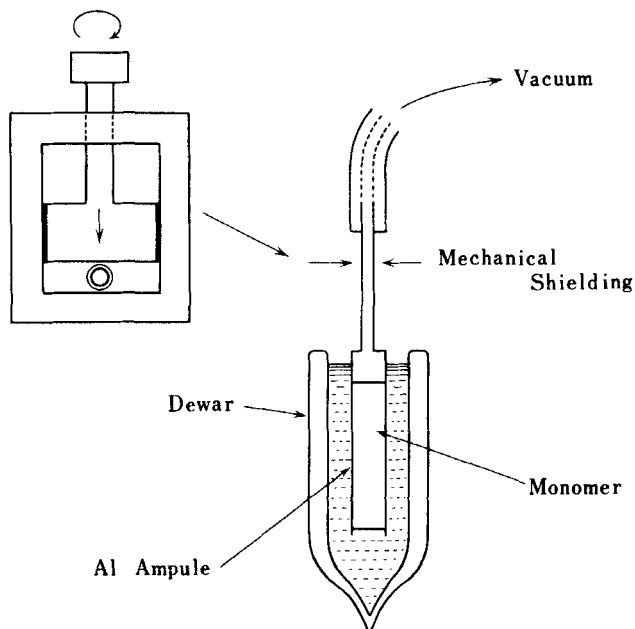

Fig. 1. Preparation of ampoules. The ampoule was shielded under 10^{-3} to 10^{-4} mm Hg.

trons was 2.1×10^{12} n/cm²/sec (> 1 MeV), the flux of thermal neutron, 1.7×10^{13} n/cm²/sec, and the flux of γ rays 9.1×10^7 rads/hr. The intensities of fast and thermal neutrons were determined by foil activations of Co and Ni. The outline of the cooling device for the irradiation is shown in Fig. 2. The details of the procedure have been reported by Bochirol et al. [3].

After irradiation, the irradiated monomer ampoules were kept at liquid-nitrogen temperature for 20 to 40 hr to eliminate the radioactivity and to prevent postpolymerization, the ampoule was opened under cooling, and methanol was introduced immediately.

The yield of polymerization was determined gravimetrically. The viscosities of polymers obtained and the infrared spectra of polymers were measured. Electron spin resonance spectra of polymers were also measured.

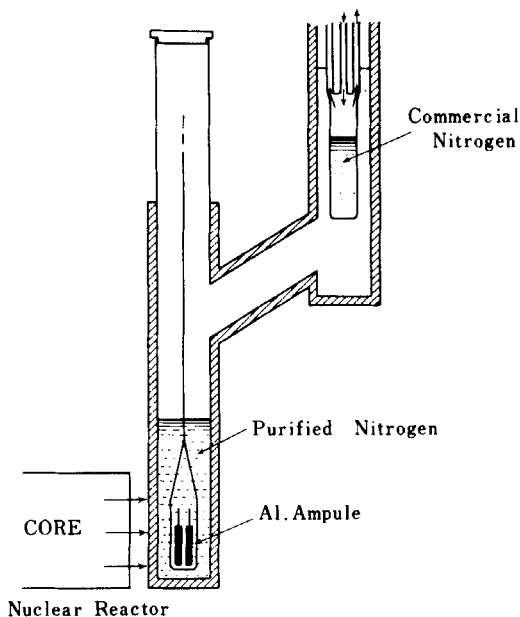

Fig. 2. Schematic diagram of the cryogenic irradiation facility.

Radiation Intensity and Elevation of Temperature Inside the Ampoule

To estimate the total deposited energy, the contributions from fast neutrons, thermal neutrons, and γ rays should be taken into consideration. Assuming the mean neutron energy to be 1 MeV, and considering the cross sections of H, C, and N nucleons to be 3.0, 2.0, and 1.8 barns [4] for the neutron energy, the deposited energy into the solid acrylonitrile can be calculated to be 2.5×10^7 rads/hr.

The absorbed dose rate by the thermal neutrons is attributed partially to the (n, γ) reaction of hydrogen atom. The cross section of hydrogen atom for thermal neutron is 0.33 barn, the kinetic energy of recoiled deuterons from the nuclear reaction is 1.4 keV, and the kinetic energy is absorbed in the system and about 1% of energy of the induced γ rays is absorbed. Therefore, the dose rate

is estimated to be 7.0×10^5 rads/hr as the contribution from the nuclear reaction of hydrogen atoms. The contribution of the $^{14}\text{N}(n, p)^{14}\text{C}$ reaction to the absorbed dose rate can be estimated to be 1.4×10^7 rads/hr. Finally, the intensity of γ rays determined by the calorimetry was 9.1×10^7 rads/hr. Therefore, the total absorbed dose rate was 13.1×10^7 rads/hr. This corresponds to 0.276 W/g.

The temperature elevation inside the ampoule during irradiation is a very important problem in these kinds of experiments. The heat conductivity of organic compounds at low temperature is believed to be in a region 1/1600 to 1/1200 (cal/cm-sec-°K). The temperature distribution inside the ampoule was calculated, assuming an infinite long cylindrical model for the sample (Fig. 3).

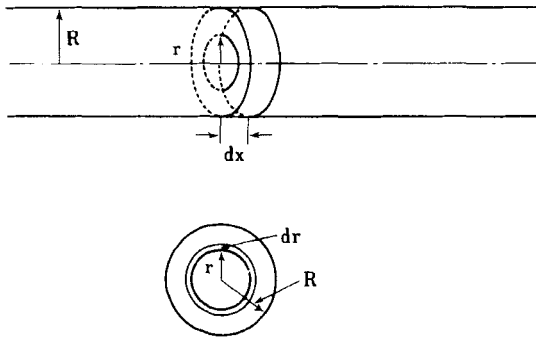

Fig. 3. Infinite cylindrical model.

In a homogeneous radiation field, the rate of energy deposition can be assumed to be equal in all parts of the sample. Let the rate of energy deposition be q_0 (cal/sec-cm³), the conductivity be K (cal/sec/cm/°K), and the temperature at r be Θ (°K). In a steady state, the following differential equation is obtained:

$$\frac{d^2\Theta}{dr^2} + \frac{1}{r} \frac{d\Theta}{dr} + \frac{q_0}{K} = 0$$

As the boundary conditions,

$$r = \begin{cases} R \longrightarrow \Theta = \Theta_0 \\ 0 \longrightarrow \frac{d\Theta}{dr} = 0 \end{cases}$$

Resolving the differential equation, we get the following solution:

$$\Theta - \Theta_0 = -\frac{q_0 R^2}{4K} \left[\left(\frac{r}{R} \right)^2 - 1 \right]$$

$$\frac{\Theta}{\Theta_0} = 1 + \frac{q_0 R^2}{4K\Theta_0} \left[1 - \left(\frac{r}{R} \right)^2 \right]$$

The mean value of the internal temperature is given by

$$\bar{\Theta} = \Theta_0 + \frac{q_0 R^2}{6K}$$

The total energy deposition q_0 by fast neutrons, thermal neutrons, and γ rays is 0.276 W/g, that is, 0.065 cal/g/sec.

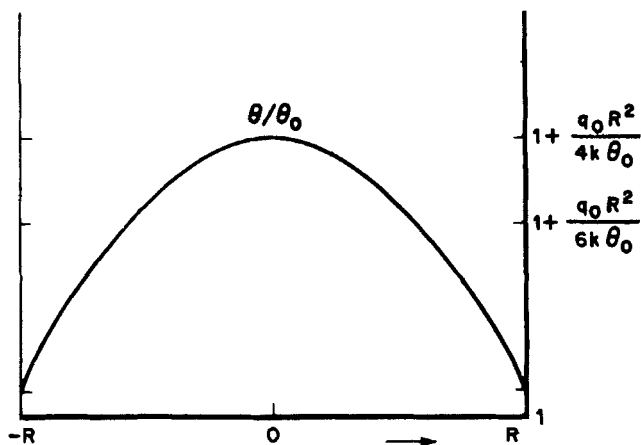

Fig. 4. Temperature distribution inside the ampoule.

The thermal conductivity of aluminum at -160°C is 0.514 (cal/sec/cm $^{\circ}\text{K}$). The value is 10^3 times greater than organic solids. To estimate the internal temperature of the sample, the effect of the aluminum wall (the thickness is 0.5 m/m) can be neglected.

The temperature in the center of the ampoule is -145°C , and the average temperature of monomers is -162°C . The transition point of the solid monomer is in the region -120 to -140°C . Actually, the polymerization proceeds below the transition temperature (Fig. 4).

RESULTS AND DISCUSSION

The relation between the conversion and the irradiation time is shown in Fig. 5. The intensities of fast neutrons, thermal neutrons, and γ rays are high enough that after 5 min of irradiation conversion of monomers proceeds at a very high rate. It is thus not possible to know accurately the initial stage of polymerization.

The polymerization behavior was compared with that induced by γ rays and electron beam. This is shown in Fig. 6. It is known that

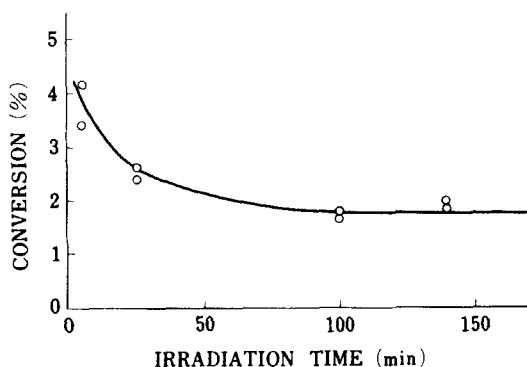

Fig. 5. Relation between conversion and irradiation time. Irradiation was carried out using an irradiation vessel in a liquid-nitrogen bath.

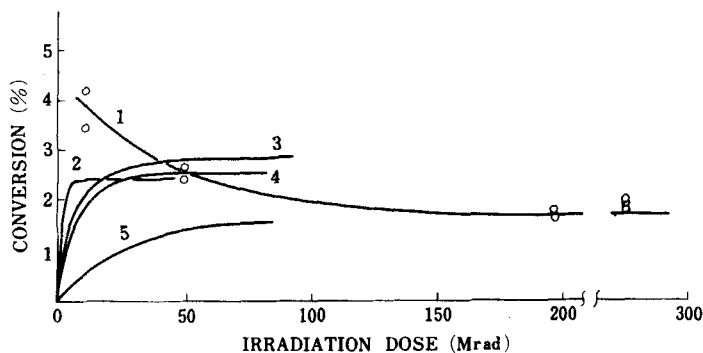

Fig. 6. Comparison of the conversion-irradiation dose relationship in the reactor experiments with other experimental results: 1, reactor radiation; 2, ^{60}Co γ rays, 6.5×10^4 rads/hr; 3, 4, electron beam from Van de Graaff (2 Mev), 3×10^5 rads/sec for rapidly cooled monomers; 5, electron beam from Van de Graaff (2 Mev), 3×10^5 rads/sec for annealed monomers.

the rate of polymerization is profoundly affected by the crystal and crystalline structure of monomers. The figure shows that these effects are very significant in the case of electron irradiation (curves 3, 4, and 5). It seems that the initial rate of polymerization is most rapid in reactor irradiation, compared with other cases. This is not due to intensity effects because the radiation intensity is much higher in electron irradiation than in pile irradiation. This is probably due to the broad spectrum of energies of γ rays (0 to 7 MeV).

The figure also indicates that conversion decreases with irradiation time. These phenomena have never been observed in other radiations except for polymerization in the later stages of polymerization induced by extremely high energy protons [5]. This is mainly due to the effect of fast neutrons, by which the crystal monomers and polymers formed are degraded.

The results of viscosity measurements are shown in Fig. 7. Viscosity was measured in dimethylformamide at 35°C. The results suggest that the molecular weight of polymers decreases more rapidly in pile irradiation than in others. It is also due to the deg-

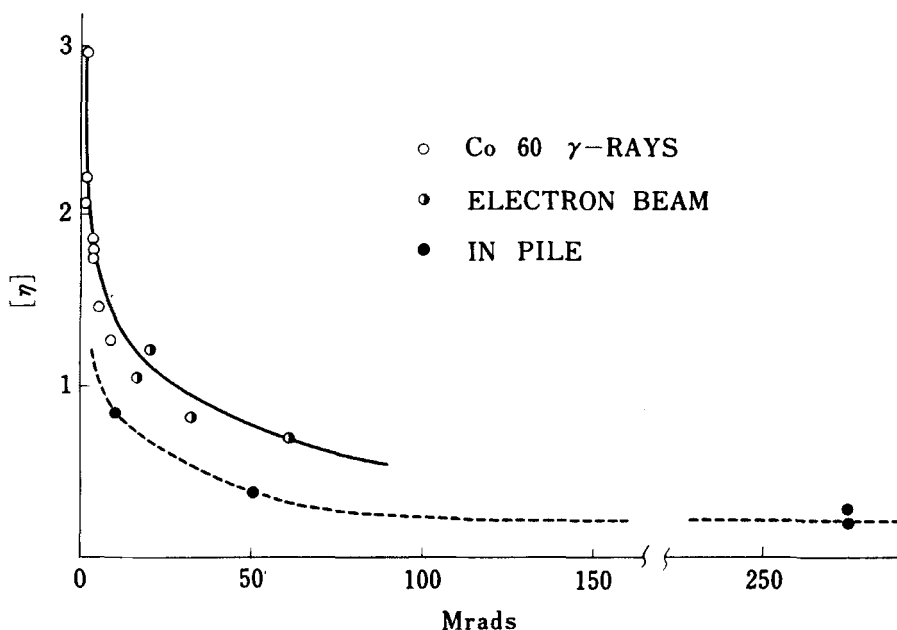

Fig. 7. Relations between intrinsic viscosity and irradiation dose in polymerization induced by three different kinds of radiation sources

radiation of polymer chain lying in the monomer crystals by fast neutrons and by recoil deuterons and protons produced inside the sample by nuclear reactions of hydrogen and nitrogen nucleons with thermal neutrons.

For neutron bombardment, the mean energy of the primary knock-on \bar{T} is given by the following equation [6]:

$$\bar{T} = f2M_1M_2/(M_1 + M_2)^2 \bar{E}$$

Here M_1 is the mass of neutron, M_2 the mass of an atom of the sample, \bar{E} the mean energy of the bombarding neutrons, and f a factor correcting for anisotropy and inelasticity in fast neutron scattering. For a carbon atom f is taken as 0.84, and a nominal value of $f = 2/3$ may be employed.

For 1-MeV neutron bombardment, the mean energies of the primary knock-on \bar{T} for the each element are calculated as follows:

$$\bar{T}_H = 0.33 \text{ MeV}$$

$$\bar{T}_C = 0.12 \text{ MeV}$$

$$\bar{T}_N = 0.10 \text{ MeV}$$

The mean number of displacements per primary displaced atom becomes

$$\bar{\nu} = \frac{\bar{T}}{2E_d}$$

where E_d is a threshold value for displacing an atom and is taken as 25 eV in most cases.

The mean number of atoms displaced per unit volume by heavy particle bombardment, N_d , is given by

$$N_d = \phi n \delta \bar{\nu} t$$

where ϕ is the flux density, t the time of bombardment, n the number of atoms per unit volume in the specimen, and δ the cross section per atom for collisions that produce displacements.

As a first approximation, the number of displaced atoms can be calculated using $\bar{\nu}$. The energy loss by ionization was not taken into consideration.

For solid acrylonitrile, the number of monomers per gram is 1.14×10^{22} , and the numbers of C, N, and H atoms are 3.42×10^{22} , 1.14×10^{22} , and 3.42×10^{22} atoms/g.

Assuming that the average energy of fast neutrons is 1 MeV, the numbers of displacements of carbon, nitrogen, and hydrogen are 3.4×10^{14} , 2.8×10^{14} , and 14×10^{14} atoms/g-sec, respectively.

Therefore, the total number of displacements of the atoms is 2×10^{15} atoms/g-sec, as a first approximation.

This value is overestimated because the energy loss by ionization is neglected. Also, it is possible for the hydrogen atom to diffuse in the solid monomer at this temperature, and so the displaced hydrogen atoms are not fixed in a definite position. It seems that the real displacement atoms may be in the region of 1 to 5×10^{14} atoms/g-sec.

For an irradiation of 80 min, the number of defects becomes 5×10^{17} to 2.5×10^{18} atoms/g. This indicates that 0.025 to 0.005% of atoms were displaced by the bombardment of neutrons.

It is possible that the interstitial atoms deform the crystal lattice in an appreciably long distance. As a result, bombardment by fast neutrons can have a great effect on the solid monomer system, that is, the deformation and degradation of crystals and the chain scission of the produced polymers. Therefore, it can be expected that the degree of polymerization and the yield of polymerization decrease with the irradiation dose.

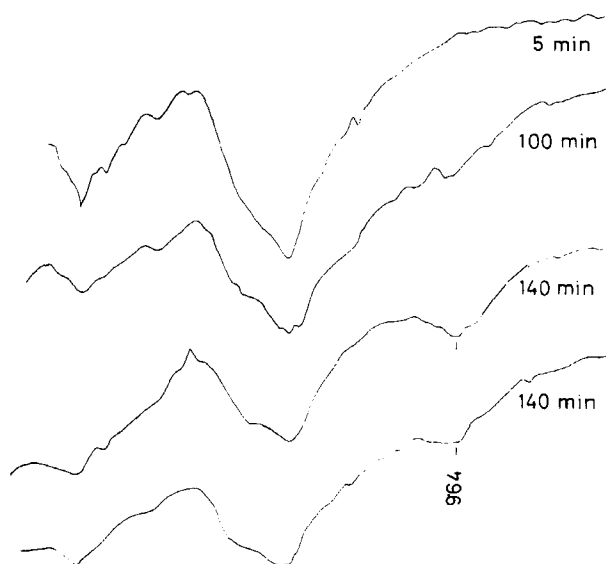
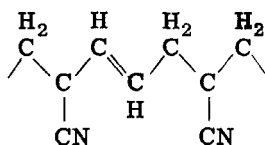

Fig. 8. Infrared spectra of polymers obtained at various irradiation times in the region 800 to 900 cm^{-1} .

Infrared spectra of polymers obtained are shown in Figs. 8 and 9. The absorption at 946 cm^{-1} is due to the trans-vinylene structure:



The amount of the double bonds increases with irradiation time. The formation of the structure is due to the irradiation effects on the polyacrylonitrile produced. Such a phenomenon has been observed only in polymerization with high-energy electrons above 15 MeV [2], and it may be due to the recoil effects of high-energy electrons. In pile irradiation the formation of trans-vinylene structure is due to the irradiation effect of fast neutrons.

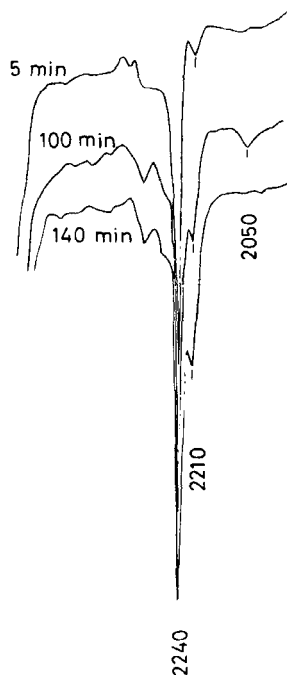
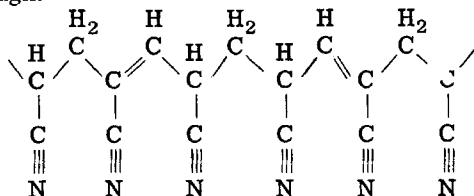

Fig. 9. Infrared spectra of polymers obtained at various irradiation times in the region $2000\text{ to }2300\text{ cm}^{-1}$.

On the other hand, a strong absorption at 2210 cm^{-1} was observed, as shown in Fig. 9. The absorption may be due to a conjugated $\text{C}\equiv\text{N}$ bond with $\text{C}=\text{C}$ double bonds. The other possible explanation is the formation of alkyne bond $-\text{C}\equiv\text{CH}$ by the $^{14}\text{N}(n, p)^{14}\text{C}$ reaction, because the neutron cross section of the reaction is large enough:



The formation of the double bond was observed first in pile irradiation. This was not observed in irradiation by high-energy electrons above 15 MeV. It may be also a recoil effect by fast neutrons.

Electron spin resonance spectra of polymers obtained were measured using a K-band spectrometer. It was shown from the experiments that appreciably large amounts of free radicals exist in the polymers. The half-width of the spectrum decreases with irradiation time. It indicates that the formation of conjugated double bonds increases with irradiation dose. These phenomena have not been observed in the polymerization induced by γ rays.

CONCLUSION

1. The solid-state polymerization of acrylonitrile induced by reactor radiation at low temperature was carried out. The total radiation intensity was high enough and was 1.2×10^8 rads/hr (0.276 W/g) for solid acrylonitrile.
2. The temperature in the center of monomers was estimated to be -145°C and the average temperature of specimen -160°C in a liquid-nitrogen irradiation vessel.
3. The initial rate of polymerization was not possible to obtain exactly, but it seems that the rate is most rapid in comparison with other radiations. It might be due to the broad energy spectrum of γ rays.
4. It was found from the viscosity measurements of polymers obtained that the molecular weight of polymers decreases with irradiation time, and the values are lower in experiments with the nuclear reactor than in the other cases with γ rays and fast electrons.
5. It was observed that the yield of polymerization decreases with irradiation time. This may be due to the degradation of polymers by further irradiation with the high-flux fast neutrons.

6. The formation of trans-vinylene was observed. This is a characteristic phenomenon in polymerization induced by reactor radiation or high-energy electrons (> 15 MeV). It may also be due to the recoil effects by fast neutrons in the case of the experiment with a nuclear reactor. The absorption at 2210 cm^{-1} has been observed only in polymers obtained by reactor experiments.

7. All polymers obtained in our experimental condition were soluble in dimethylformamide.

8. Appreciably large amounts of stable radicals were observed in the polymers obtained.

ACKNOWLEDGMENTS

The author wishes to express thanks to Mr. P. Lévêque and Mr. J. Puig of Le Service de Physico-Chimie Appliquée, C.E.N., Saclay, and Dr. L. Bochirol and Dr. Téoule and Mr. J. Le Calvez of Le Section Physico-Chimie et Basses Températures, C.E.N., Grenoble, for useful discussions, technical assistance, and many practical suggestions.

REFERENCES

- [1] H. Sobue and Y. Tabata, *J. Polymer Sci.*, **43**, 459 (1960); R. Bessanson and R. Marx, *J. Polymer Sci.*, **48**, 53 (1960); Y. Amagi and A. Chapiro, *J. Chim. Phys.*, **50**, 537 (1962); I. M. Barkalov, V. I. Goldanskii, N. E. Enikolopyan, S. F. Terekhova, and G. M. Trofimova, *J. Polymer Sci.*, **B4**, 897 (1964).
- [2] Y. Tabata, S. Shu, and K. Oshima, paper presented at Annual Meeting of Chemical Society of Japan, April, 1964; Y. Tabata, S. Shu, S. Hayakawa, and K. Oshima, paper presented at Annual Meeting of American Chemical Society, Chicago, Aug. 31, 1964, *Polymer Preprints*, **5**(1), 986 (1964); Y. Tabata and K. Oshima, paper presented at International Symposium on Macromolecular Chemistry, Prague, Sept. 1965, Preprint P605.
- [3] L. Bochirol, J. Doulat, and L. Weil, *Cryogenics*, **1**, (1), 44 (1960); L. Bochirol, J. Doulat, and L. Weil, *Rapport C.E.A.*, **1827** (1961); L. Bochirol, J. Le Calvez, J. Doulat, J. Verdier, A. Lacaze, and L. Weil, *Rapport C.E.A.*, **2514** (1964).
- [4] Neutron Cross Section, *BNL-325*.
- [5] Y. Tabata, *J. Macromol. Sci.*, **A1**, 1407 (1967).
- [6] J. J. Harwood et al. (eds.), *The Effects of Radiation on Materials*, Reinhold, New York, 1958, Chapman & Hall, London, 1958.

Accepted by editor February 27, 1968

Received for publication May 8, 1968